

Brookstone®

OSIM® uStyle2™ Massage Chair

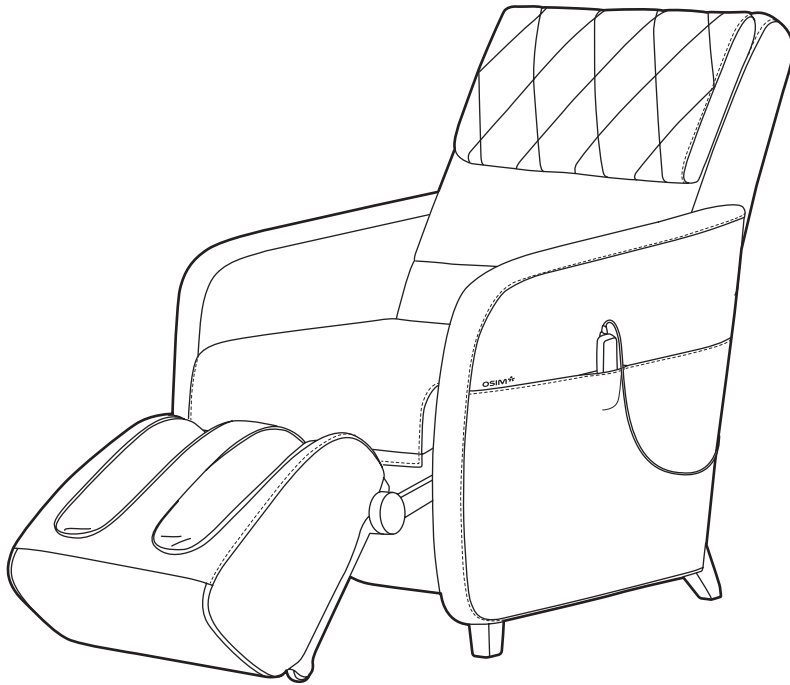

OSIM 

Exclusively for Brookstone
Designed and Developed by OSIM International Ltd.

OS-825R uStyle2

Thank you for purchasing the OSIM uStyle2 massage chair. Before you start using the massage chair, please read this operation manual thoroughly for the correct methods of usage, paying special attention to the section on safety.

Call our Delivery Support Team at 866-336-3199 if you have questions during delivery, or damage at time of delivery.

This manual should be kept on hand for easy reference. It is your guide to a safe and efficient operation.

Contents	Safety	2
	Names of parts and functions	7
	Features and effectiveness	9
	Preparation before use	10
	Massage programs and selections	14
	Product care and storage	18
	Troubleshooting	19
	Specifications	21
	Warranty	22



IMPORTANT SAFETY INSTRUCTIONS



When using the massage chair, basic precautions should always be followed, including the following:

Read all instructions before using this massage chair:

DANGER – To reduce the risk of electric shock:

1. Always unplug this massage chair from the electrical outlet immediately after use and before cleaning.
2. Never use pins or other metallic fasteners with this appliance.
3. Carefully examine the covering before each use. Call for service if the covering shows any sign of deterioration, such as blistering, peeling or cracking.
4. Keep dry - Do not operate in a wet or moist condition.

WARNING – To reduce the risks of burns, fire, electric shock, or injury to persons:

1. READ ALL INSTRUCTIONS BEFORE USING.
 2. The massage chair should never be left unattended when plugged in. Unplug from outlet when it is not in use, and before putting on or taking off parts.
 3. Close supervision is necessary when this massage chair is used by, on or near children or disabled persons. Keep children away from extended back, foot support (or other similar parts).
 4. Use this massage chair only for its intended use as described in this manual. Do not use attachments not recommended by the manufacturer.
 5. Never operate this massage chair if it has a damaged cord or plug, if it is not working properly, if it has been dropped or damaged, or dropped into the water. Contact Brookstone Customer Service at 866-336-3199.
 6. Do not carry this massage chair by the power cord or use cord as a handle.
 7. Keep the power cord away from heated surfaces.
 8. Never operate the massage chair with the air openings blocked. Keep the air openings free of lint, hair, and the like.
 9. Never drop or insert any object into any openings.
 10. Do not use outdoors.
 11. Do not operate where aerosol (spray) products are being used or where oxygen is being administered.
 12. To disconnect, turn all controls to the off position, then remove the plug from the outlet.
 13. Do not stand on or in the massage chair. Use only while seated.
 14. The product is not intended for use by children or persons with reduced physical, sensory or mental capabilities, or lack of experience and knowledge, unless they are supervised and have been given instructions concerning use of the product by a person responsible for their safety.
- 
- 

SAVE THESE INSTRUCTIONS

This massage chair is intended for household use only



Safety

Usage environment

- Do not use the massage chair in an excessively humid or dusty environment as it may result in malfunction or electric shock.
- Do not use the massage chair in a room with a temperature of 104°F or higher.
- Do not expose the massage chair to heaters, stoves or direct sunlight.
- Place and use the massage chair on an even, non-slip floor.
- The massage chair is designed for home use and not for commercial purposes.

Caution

- The massage chair is to be used indoors only.
- If you use the massage chair in a cold room, do not increase the room temperature abruptly. It is recommended that you increase the temperature gradually to a normal level.
- If the massage chair is stored in a cold place and is being brought into a warm environment, it is advisable to wait one hour before use. This is because its performance may not be at optimum level, as there may be water droplets on mechanical parts due to condensation. Using the massage chair under such conditions may result in malfunction.

Safety precautions

- To ensure safe and correct use of the massage chair, do not operate it without reading this operation manual carefully.
- Do not use the massage chair when the upholstery or seat is removed. This may cause injury or malfunction.
- Do not use the massage chair in combination with other therapeutic equipment or electric blanket, etc, as this may result in ineffectiveness or injury.
- Do not use the massage chair an hour before or after eating as this may have adverse effects on the user.
- Do not allow children or pets to play around the massage chair, e.g., behind the backrest, under the seat or leg rest of the massage chair. This may result in injury.
- Do not rest or place heavy objects on the armrests, footrest or backrest as this may result in malfunction or injury.
- Do not use the massage chair when your body is wet.
- Do not operate the massage chair with wet hands.
- It is not recommended to use the massage for more than 15 minutes.
- Do not perform continuous massage on the same spot of your body for more than 5 minutes at a time as this may result in excessive stimulation and may have adverse effects.
- Do not insert your hand or foot along the paths of the massage rollers during use as this may cause injury.
- Stop operation immediately if you experience any discomfort.

Safety

- This massage chair is not intended for self-diagnosis or self-treatment of conditions that should be managed by a qualified health care provider.
- People under medication or with medical conditions, please consult your doctor before use. Please do not use the massage chair if you are not feeling well.
- Remove all scarves, neckties, necklaces and jewelry before using the massage chair.

People with Medical Conditions

Consult your doctor before use if you:

- are under medical rest as ordered by a doctor.
- have spinal disorders, an abnormal spinal condition or have suffered a spinal injury.
- have back problems.
- have diabetes, osteoporosis or sensory impairment.
- have joint dysfunction.
- have a pacemaker or other electronic medical devices.
- may be pregnant.
- have phlebitis or thrombosis.
- have an increased risk for blood clots.
- had recent surgery.
- have surgical pins, screws or anything mechanical implanted in your body.

Caution

- Avoid using the massage chair under the influence of alcohol.
- Do not apply massage rollers directly on head, elbow and knee joints, torso or abdomen.
- If your legs or feet slip off the footrest during massage, do not force them back in as this may result in injury.
- Remove power plug from the electrical outlet immediately should liquid be accidentally spilled onto the massage chair. Do not use wet hands to connect or disconnect the power plug from the electrical outlet.
- Do not tamper with the power cord or use the massage chair with a damaged cord as this may result in malfunction and electric shock.

Safety

Instances when the massage chair should not be used

In the following events, please switch off the main power switch immediately and disconnect the power cord from the electrical outlet:

- If water is accidentally spilled onto the massage chair. This may result in electric shock or malfunction.
- If the fabric of the backrest is torn and the internal components are exposed.
- If pain or discomfort is felt during massage, stop operation immediately and consult your doctor.
- If you detect any malfunction or any other abnormal condition during operation.
- If there is a power failure. Injury may occur when power is restored unexpectedly.
- If there is lightning.

Assembly and repair of the massage chair

- Do not disassemble the backrest cover of the massage chair. Touching the internal components of the massage chair may result in malfunction or electric shock.
- The massage chair must only be professionally serviced or repaired. Do not attempt to disassemble or repair the massage chair.

Things to note about the power plug and cord

- **Check that the Alternating Current (AC) voltage corresponds with the specifications indicated for the massage chair.**
- Do not connect or disconnect the power plug from the electrical outlet with wet hands. This may result in malfunction or electric shock.
- When disconnecting the power plug, pull it out by holding the plug, not the cord.
- Although operation will be stopped automatically by the Auto-Timer function, always remember to switch off the main power switch after use.
- Do not place the power cord under the massage chair or any other heavy objects.
- Do not wind the power cord around the massage chair as this may damage the cord and result in a fire or electric shock.
- Do not operate the massage chair with a damaged cord or extension cord.
- Do not use the massage chair if the electrical outlet is loose.
- If the power cord is damaged, it should be replaced by a qualified technician.

Safety

Grounding Instructions

This product must be grounded. If it should malfunction or break down, grounding provides a path of least resistance for the electric current to reduce the risk of electric shock. This product is equipped with a cord with an equipment-grounding conductor and a grounding plug. The plug must be plugged into an appropriate outlet that is properly installed and grounded in accordance with all local codes and ordinances.

DANGER - Improper connection of the equipment-grounding conductor can result in a risk of electric shock. Check with a qualified electrician or service technician if you are in doubt as to whether the product is properly grounded. Do not modify the plug provided with the product - if it will not fit the outlet, have a proper outlet installed by a qualified electrician.

This product is for use on a nominal 120V circuit and has a grounding plug that looks like plug illustrated below. Make sure that the product is connected to an outlet having the same configuration as plug. No adaptor should be used with this product.

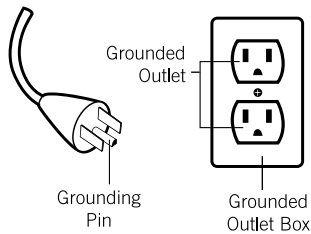

Names of parts and functions

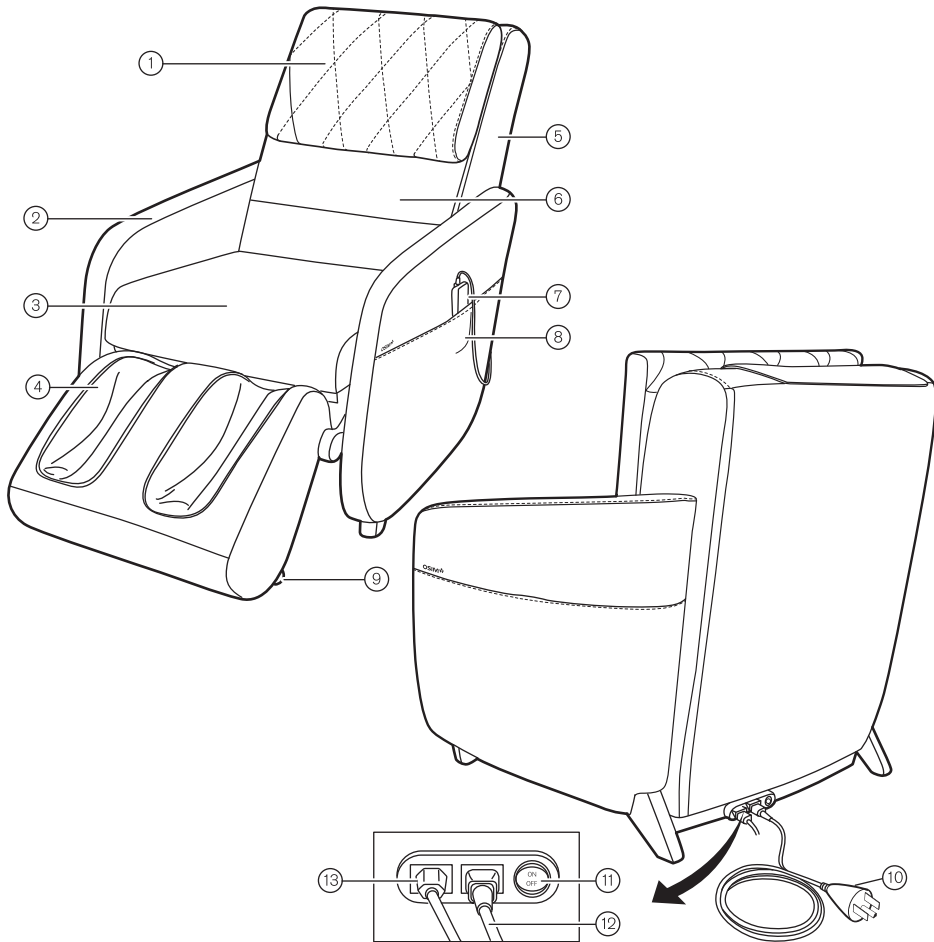

1. Headrest cushion
2. Armrest
3. Seat cushion
4. Footrest
5. Backrest
6. Backrest cover
7. Controller

8. Controller side pocket
9. Casters
10. AC plug*
11. Main power switch
12. AC cord
13. Controller cord

*Parts may differ from those shown in illustration.

Names of parts and functions

Controller

Home button

To stop on going massage program. Rollers will return to storage position.

Backrest/Footrest positioning buttons

To incline/recline the backrest and to extend/retract the footrest.

Roller Width adjustment button

To adjust the width of the rollers (Wide, Medium, Narrow).

Roller Adjustment buttons

To adjust the rollers position during manual massage program.

Foot Massage program button

To activate foot kneading massage program (Hi, Lo, Auto).

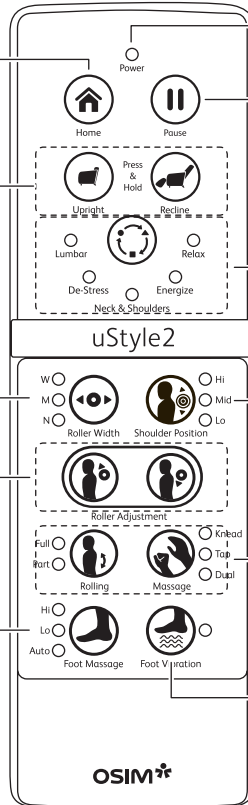

Power indicator

Illuminates while the power is on.

Pause button

To stop chair operation immediately (Press the Home button for rollers to return to its storage position).

Automatic massage program buttons

Refer to page 13 for details.

Shoulder Position adjustment button

To adjust the roller position for shoulders (5 levels).

Manual massage program buttons for backrest

Refer to page 14 for details.

Foot Vibration message program button

To activate Foot Vibration massage program.

⚠ Caution

- Do not sit, step or place heavy objects on the controller.
- Refrain from dropping the controller. It is recommended that the controller unit be placed in the controller pocket when not in use.
- Do not exert excessive force on the controller.
- Do not handle the controller with wet hands.
- Do not operate the controller using sharp-edged or hard objects. It may result in damage.

Features and effectiveness

Features

- Mini massage chair with relaxing back and foot massages
- 5 Automatic massage programs (Relax, Energize, Neck & Shoulders, De-Stress, Lumbar)
- 9 Manual massage programs (Kneading, Tapping, Dual, Full Rolling, Partial Rolling, Foot Massage with high / low / auto speed, Foot Vibration) allow user to customize desired massage.
- Deep massage using a 4-roller system on the upper body
- Foot massage using kneading discs and rollers with adjustable speeds (Hi, Lo, Auto)
- Footrest with vibration function
- Shoulder position adjustment functions for backrest rollers, to provide a more personalized massage
- Roller position adjustment
- Roller width adjustments (Wide, Normal, Narrow)
- Retractable footrest to give you more living space
- Detachable and washable footrest massage fabric cover for better hygiene
- 15 minutes auto-timer
- Controller with LED indicators for easy operation
- Compact and stylish design to complement any modern interior

Effectiveness

Helps:

- Relieve fatigue
- Improve circulation
- Relieve stiff and aching muscles
- Relieve stress and tension
- Promote relaxation

Preparation before use

Setting up the massage chair

- The massage chair is packed with its backrest and footrest in its storage position.

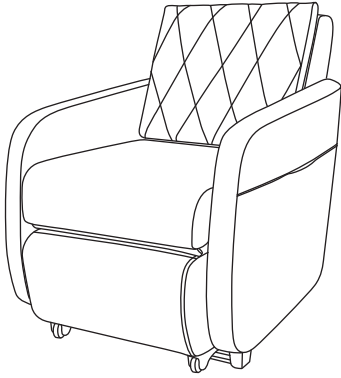

Placing the headrest cushion

- Align the headrest cushion and backrest as shown and secure the headrest cushion with the zipper.

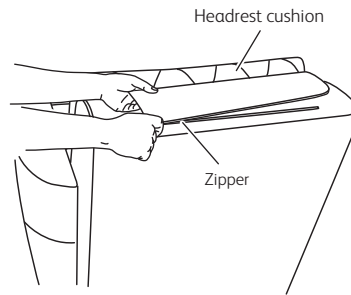

Removing the Buffer Pad

- Remove the buffer pad behind the backrest cushion as shown if you prefer a more intense massage.

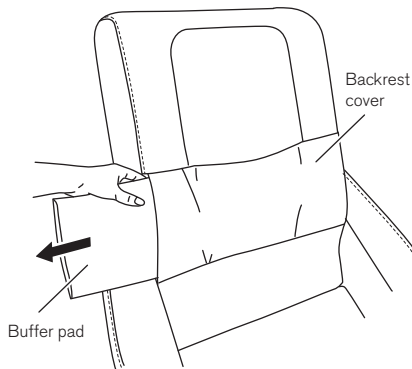

Preparation before use

Moving the massage chair

- Retract the backrest and footrest fully to its storage position.
- Ensure that all switches are turned off and disconnect the power plug from the electrical outlet.
- Tilt the front of the massage chair up and hold the side frame as shown.

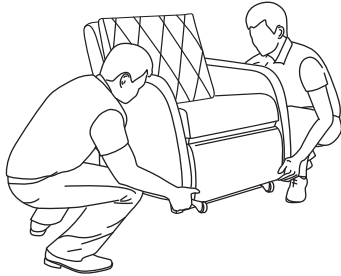

- Lift up the massage chair and move it to the desired location as shown.



Caution

- Do not move the massage chair when someone is sitting on it. This will cause the massage chair to tip over and cause accident and injury.

Preparation before use

Placing the massage chair

- Ensure that there is a minimum clearance of 16" behind the massage chair and 24" in front of the massage chair to allow the backrest to recline and the footrest to extend without obstruction during operation.
- Maintain a minimum distance of 40" from AV devices such as television or radio to prevent signal interference.

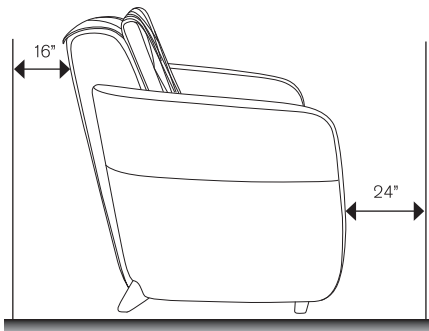

- As the massage chair is heavy, please exercise extra care not to damage floor surfaces when positioning it.
- It is recommended that a carpet is placed under the massage chair to prevent damaging floor surfaces and to reduce noise level during operation.

Power On/Off

- Connect the power plug to the electrical outlet.
- Turn on/off the main switch located at the lower back of the massage chair.

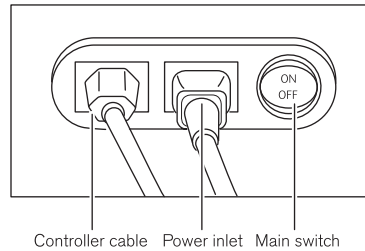

Caution

- Ensure that the power cord is not placed under the massage chair.
- Make sure all switches are turned off (including the main power switch) before the power plug is connected to an electrical outlet.

Note

- If the rollers are located at the middle of the backrest when operation is terminated, they will return to their storage position when the Reset button on the controller is pressed or the main power switch located behind the massage chair is turned on again.

Preparation before use

Reclining the backrest and extending the footrest

- Press and hold the Recline button [] until the backrest and footrest are fully extended.

Note

- Do not exert force or lean on the backrest when you recline the chair or when you are ready to bring the chair back to its upright position as it will activate the product safety features which cause the massage chair to remain stationary.

After using the massage chair

Retracting the backrest and footrest

- Press and hold the Upright button [] to return the backrest and footrest to its storage position.
- Turn off the main power switch which is located at the lower back of the massage chair.

Caution

- To prevent accidents and malfunction of the massage chair, switch off the main switch and disconnect the power plug from the electrical outlet after use.
- Always disconnect the power plug from the electrical outlet if the massage chair is not being used for a period of time.

Note

- Although operation will be stopped automatically by the auto-timer function, always remember to switch off the main switch after use.

In the event of power failure

- With the support of the side frames, lift and move your body to the edge of the seat as shown in Fig. 1.
- Lift your knees upwards and ease your legs out as shown in Fig. 2.

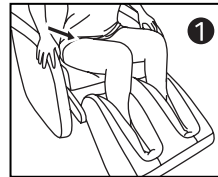

Fig. 1

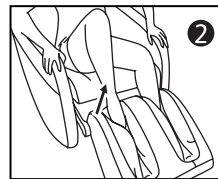



Fig. 2

- Turn off the main switch and disconnect the power cord to prevent any sudden operation if the power is restored unexpectedly.

Massage programs and selections

Automatic massage programs

- Press and hold the Recline button [] until the backrest and footrest are fully extended.
- Choose the 5 automatic programs in the following sequence to suit your needs.

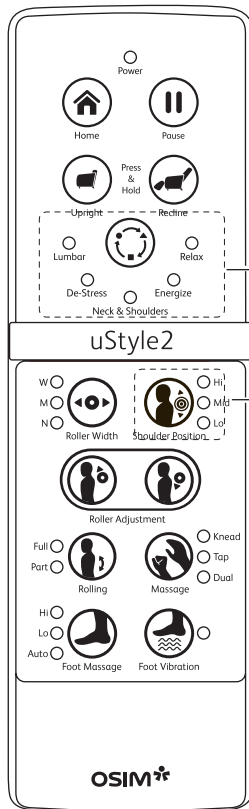

1 Adjust to your desired roller position for shoulders by pressing the Shoulder Position button [] (5 Levels).

Select any of the 5 automatic programs:

- Relax** - Head-to-toe pampering to help relax the body & mind.
- Energize** - Intense massage to help stimulate & invigorate the body & mind.
- 2 Neck & Shoulder** - To help quickly relieve aches & tension on the Neck & Shoulders.
- De-Stress** - Helps de-stress the body & mind for better daily well-being.
- Lumbar** - Loosen back tension to help maintain a healthy back.



Once an automatic program button is pressed, the respective LED indicator will illuminate.

3 The selected automatic massage program will begin.

4 You can remove the Foot Massage and Foot Vibration massage by pressing the respective buttons.
The LED indicator light will not illuminate.

5 After the massage is completed, the rollers will return to the storage position.

Note

- In an emergency or any malfunction, press the Pause button [] to stop the massage immediately. Press the Home button [], rollers will return to storage position. Turn off the main switch.
- You can change from one Automatic program to another program at any time without having to wait for it to complete. However, changing between programs will not reset the timer.
- Each massage session is 15 minutes.

Massage programs and selections

Manual message programs

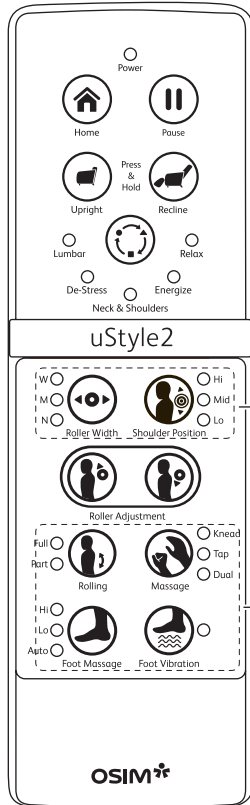

- 1 Select and combine manual massage programs from menus 1 and 3 according to your preference.
- 2 The selected manual massage programs begin.
- 3 During operation, you can adjust the roller width, shoulder position or roller position depending on the selected manual massage programs.
- 4 After the massage is completed, the rollers will return to the storage position.

Menu 1

Kneading

Simulates the thumb-kneading action and circular motion of a massage therapist to help relax stiff muscles and relieve tension.

- Press Massage button once [👉] and the LED indicator will illuminate.
- Adjust roller position by pressing and holding Roller Adjustment button [👉] / [👈].

Tapping



The percussive massage works like the rolled-up fists of a skilled masseuse, helping to give you instant relief while improving circulation.

- Press Massage button [👉] twice and the LED indicator will illuminate.
- Adjust roller position by pressing and holding Roller Adjustment button [👉] / [👈].
- Adjust roller width by pressing the Roller Width button [👉] (Wide, Mid, Narrow).

Massage programs and selections

Dual





Combines the synergy of Tapping and Kneading to bring about a deeper and more effective massage.

- Press the Massage button [] three times and the LED indicator will illuminate.
- Adjust roller position by pressing and holding Roller Adjustment button [] / [].

Menu 2

Full/Partial rolling

Rollers move up and down a targeted part of the back.

- Press the Rolling button [] to switch between Full and Partial rolling massage. The respective LED indicator will illuminate.
- Adjust the roller width by pressing the Roller Width button [] (Wide, Mid, Narrow).
- Adjust roller position by pressing and holding Roller Adjustment button [] / [].
- Press the Rolling button [] again to stop the rolling massage program.

Menu 3

You can combine any or all of the following massage programs for a more personalised massage.



Foot Massage

- Press the Foot Massage button [] to switch between Auto, Hi, Lo and Off.

Foot Vibration Massage

- Press the Foot Vibration button [] to start/stop the massage.

Stopping a massage session

- Press Pause button [] to stop all massage functions immediately.
- Press the Home button [] to stop / reset the programs. Rollers will return to storage position.

Massage programs and selections

Combined message programs

You can combine different massages with the rolling features for a more effective and personalized message.

Kneading with full or partial rolling

- Press the Message button [🌀] followed by the Rolling button [👤] to select your desired rolling message during Kneading massage.

Tapping with full or partial rolling

- Press the Message button [🌀] two times followed by the Rolling button [👤] to select your desired rolling message during Tapping massage.
- Press the Roller Width button [🌀] to adjust the width of the rollers (Wide, Normal, Narrow).

Dual with full or partial rolling

- Press the Message button [🌀] three times followed by the Rolling button [👤] to select your desired rolling message during Dual massage.

Overall message

You may combine any of the following manual massage programs.

- Press any of the selected buttons and the LED indicator will illuminate.
[🌀] (Kneading/Tapping/Dual) + [👤] (Full/Partial Rolling) + [👣] (Foot Massage) + [🌀] (Foot Vibration).

Shoulder position adjustment

You can adjust the rollers to the position of your shoulders by using the Shoulder Position Adjustment button (5 levels). By default, the Shoulder Position is set at 'Mid'.

- Press the Shoulder Position button [👤] ('Hi' to 'Lo' 5 levels) to select your desired position during manual massage.
- The LED indicator will illuminate.

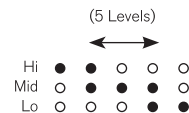

Note

- To achieve the optimum massage effect, every user is encouraged to adjust the rollers to the desired shoulder position before the start of any massage program.



Product care and storage

Chair placement and storage

Environmental factors can strongly affect the product physically and mechanically. Do not expose the massage chair to direct sunlight or in places with extreme heat or air-conditioning vents. These can cause the upholstery to dry up, crack or the color to fade.

If the massage chair is not to be used for a long period of time, cover it with a dust cover and unplug the power plug from the electrical outlet.

Clean the massage chair using a dry cloth regularly

Before cleaning, ensure that the main switch is turned off and the power plug is unplugged from the electrical outlet.

The main unit structure and fabric can be cleaned thoroughly with a piece of soft, dry cloth. The common micro-fibre cleaning materials or gloves are very well suited for this routine maintenance process. Such materials and gloves are available for sale in most DIY (Do it yourself) shops.

Do NOT use wet elements for cleaning

The massage chair is made up of electrical components and mechanical parts, which are all very sensitive to moisture. Under no circumstances should they be exposed to any form of water or moisture. If you use water (eg. a wet cloth) to clean the upholstery, the coating may be eroded and the protection for the massage chair will be diminished.

As for the controller, it may result in malfunction if you use a wet cloth to clean.

Do NOT use cleaning solvents and abrasive cleaners

Under no circumstances should you use any cleaning agents, like benzene or thinner to clean the massage chair. This may cause the color of upholstery to fade.

Do not wash the upholstery using domestic washing machine. This may result in the deterioration of upholstery quality.

Do NOT attempt to repair your product

Under no circumstances should you attempt to repair the massage chair, for safety reason. If you suspect a malfunction, always call Brookstone Customer Service at 866-336-3199 for further assistance and information.



Troubleshooting

If you encounter problems operating the massage chair, please check the following points. If the massage chair still malfunctions or does not work, please switch off the massage chair, remove the power plug from the electrical outlet and contact Brookstone Customer Service at 866-336-3199.

Do not dismantle or attempt to repair the massage chair yourself. Doing so will void the warranty and Brookstone will not be responsible for any subsequent consequences.

Problem	Possible Cause / Action
<ul style="list-style-type: none">▪ Frictional sound of rollers against backrest cover.▪ Frictional sound of rollers within the foot massage unit.▪ Motor sound during operation.▪ Loud sound during tapping and kneading program.	<ul style="list-style-type: none">▪ These sounds are the result of mechanical structure and not malfunction.▪ This may occur during normal usage.
<ul style="list-style-type: none">▪ The controller does not work correctly.	<ul style="list-style-type: none">▪ Check the power plug and ensure that it is securely connected to the electrical outlet.▪ Ensure that the main switch is turned 'ON'.
<ul style="list-style-type: none">▪ The power cord and plug are abnormally hot.	<ul style="list-style-type: none">▪ Stop use immediately and contact Brookstone Customer Service at 866-336-3199
<ul style="list-style-type: none">▪ The massage stops midway.	<ul style="list-style-type: none">▪ The auto-timer of 15 minutes has lapsed. Press any program button to restart the massage.▪ If the massage chair fails to restart, turn off the main power switch on the electrical outlet. Turn it on again after 10 minutes.▪ If the same problem persists, please turn off the Main Switch, disconnect the power plug from the electrical outlet and contact Brookstone Customer Service.

* Please contact Brookstone Customer Service at 866-336-3199 for information about service and repair. Product warranty is valid only in the country of purchase.

Troubleshooting

Problem	Possible Cause / Action
<ul style="list-style-type: none">▪ The massage chair does not start operation.	<ul style="list-style-type: none">▪ Ensure that the main switch and the switch on the electrical outlet is turned on.▪ Ensure that the power plug is firmly connected to the electrical outlet.▪ Check that the voltage at the electrical outlet is adequate.
<ul style="list-style-type: none">▪ The massage rollers stop during the massage session.	<ul style="list-style-type: none">▪ The roller mechanism may be strained when subjected to excessive force.▪ Do not apply excessive force on the rollers.
<ul style="list-style-type: none">▪ The foot massage unit does not function.	<ul style="list-style-type: none">▪ Please ensure that the foot massage unit is fully extended.
<ul style="list-style-type: none">▪ The LED indicator beside the button on the controller flashes.	<ul style="list-style-type: none">▪ Turn off the switch on the electrical outlet. Turn it on again after 5 seconds.▪ Check that the voltage at the electrical outlet is adequate.▪ If the same problem persists, please turn off the main switch, disconnect the power plug from the electrical outlet and contact Brookstone Customer Service.
<ul style="list-style-type: none">▪ The backrest does not recline or return to its upright position.	<ul style="list-style-type: none">▪ Product safety switches may have engaged. Make sure that there is no force being placed on the backrest (will not function if you are leaning back against the backrest).

Specifications

Model number/name	OS-825R uStyle2
Voltage available	110-120V~ 60Hz
Power consumption	Approx. 125W
Auto timer	Approx. 15 minutes
Backrest massage unit	
Kneading speed	Approx. 40 rpm
Kneading width	Approx. 3" to 6.3"
Backrest reclining angle	Approx. 60 to 75 degree
Tapping speed	Approx. 460 rpm
Tapping width	Approx. 3" to 6.3"
Rolling distance	Approx. 13.8" (Full) / 5.5" (Partial)
Rolling speed	Approx. 0.8" per sec
Rolling width	Approx. 3" to 6.3"
Footrest massage unit	
Kneading speed	Approx. 20 rpm (Low), 25 rpm (High)
Vibration speed	Approx. 1900 rpm
Dimensions	
Backrest inclined/Footrest retracted	Approx. 27.6" (W) x 35" (L) x 34.6" (H)
Backrest reclined/Footrest extended	Approx. 27.6" (W) x 63.8" (L) x 41.3" (H)
Weight	
Net weight	Approx. 111.1 lbs
Gross weight	Approx. 132.3 lbs

ONE (1) YEAR LIMITED WARRANTY

Brookstone® warrants this product against defects in materials and/or workmanship under normal use for a period of ONE (1) YEAR from the date of purchase by the original purchaser ("Warranty Period"). If a defect arises and a valid claim is received within the Warranty Period, at its option, Brookstone will either 1) repair the defect at no charge, using new or refurbished replacement parts, or 2) replace the product with a new product that is at least functionally equivalent to the original product, or 3) provide a store credit in the amount of the purchase price of the original product. A replacement product or part, including a user-installable part installed in accordance with instructions provided by Brookstone, assumes the remaining warranty of the original product. When a product or part is exchanged, any replacement item becomes your property and the replaced item becomes Brookstone's property. When a store credit is given, the original product must be returned to Brookstone and becomes Brookstone's property.

Obtaining Service: To obtain warranty service, call Brookstone Limited Warranty Service at 1-866-336-3199. Please be prepared to describe the product that needs service and the nature of the problem. A purchase receipt is required. All repairs and replacements must be authorized in advance. Service options, parts availability and response times will vary. You are responsible for delivery and the cost of delivery of the product or any parts to the authorized service center for replacement, per our instructions.

Limits and Exclusions: Coverage under this Limited Warranty is limited to the United States of America, including the District of Columbia and the U.S. Territories of Guam, Puerto Rico, and the U.S. Virgin Islands. This Limited Warranty applies only to products manufactured for Brookstone that can be identified by the "Brookstone" trademark, trade name, or logo affixed to them or their packaging. The Limited Warranty does not apply to any non-Brookstone products. Manufacturers or suppliers other than Brookstone may provide their own warranties to the purchaser, but Brookstone, in so far as permitted by law, provides these products "as is." This warranty does not apply to: a) damage caused by failure to follow instructions relating to product's use or the installation of components; b) damage caused by accident, abuse, misuse, fire, floods, earthquake or other external causes; c) damage caused by service performed by anyone who is not a representative of Brookstone; d) accessories used in conjunction with a covered product; e) a product or part that has been modified to alter functionality or capability; f) items intended to be periodically replaced by the purchaser during the normal life of the product including, without limitation, batteries or light bulbs; g) any product sold "as is" including, without limitation, floor demonstration models and refurbished items; or h) a product that is used commercially or for a commercial purpose.

BROOKSTONE SHALL NOT BE LIABLE FOR INCIDENTAL OR CONSEQUENTIAL DAMAGES RESULTING FROM THE USE OF THIS PRODUCT, OR ARISING OUT OF ANY BREACH OF THIS WARRANTY. TO THE EXTENT PERMITTED BY APPLICABLE LAW, BROOKSTONE DISCLAIMS ANY AND ALL STATUTORY OR IMPLIED WARRANTIES, INCLUDING, WITHOUT LIMITATION, WARRANTIES OF MERCHANTABILITY, FITNESS FOR A PARTICULAR PURPOSE AND WARRANTIES AGAINST HIDDEN OR LATENT DEFECTS. IF BROOKSTONE CANNOT LAWFULLY DISCLAIM STATUTORY OR IMPLIED WARRANTIES, THEN TO THE EXTENT PERMITTED BY LAW, ALL SUCH WARRANTIES SHALL BE LIMITED IN DURATION TO THE DURATION OF THIS EXPRESS WARRANTY.

Some states disallow the exclusion or limitation of incidental or consequential damages or how long an implied warranty lasts, so the above exclusions or limitations may not apply to you. This warranty gives you specific legal rights and you may also have other rights, which vary from state to state.

Find thousands more
great ideas online

Brookstone®

BK - 841262
BR - 847287
RD - 847288
WH - 847286

Merrimack, New Hampshire USA 03054 ▪ 800-846-3000 ▪ Brookstone.com Rev01